

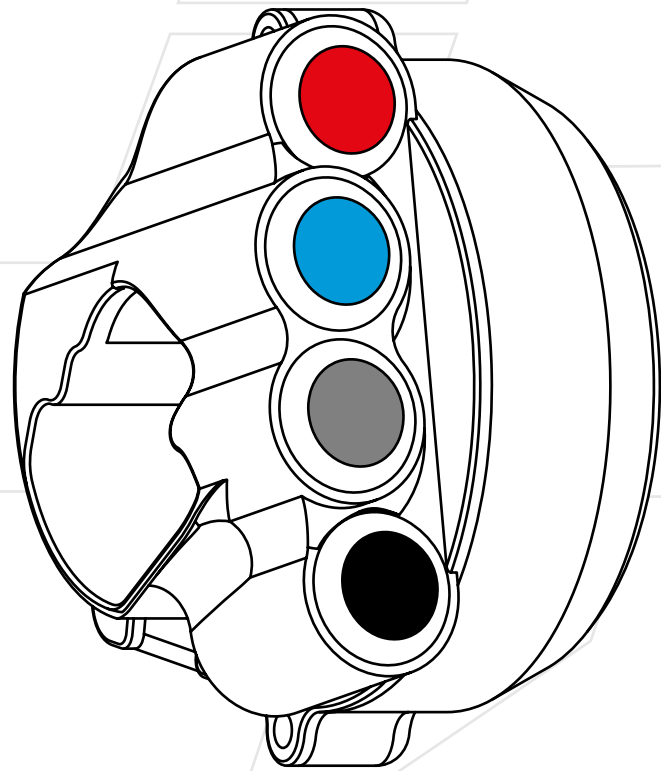

THROTTLE CONTROL WITH INTEGRATED HANDLEBAR SWITCH



Ref. JP CO BM038

TECHNICAL FEATURES

- CNC-machined anodized aluminium body
- stronger and lighter than the original part
- IP69K protection
- laser engraving
- wired with RAYCHEM 105° cable and sealed with RAYCHEM S1125 resin

INSTALLATION

This product is plug-and-play, no modification is required on the bike:

1. make sure the ignition is turned off
2. remove the bar end weight on the throttle side
3. disconnect and remove the original right handlebar switch and the electronic throttle control (refer to the manufacturer's workshop manual)
4. slide the JETPRIME throttle control half-housing on the handlebar
5. reinstall the original electronic throttle control on the handlebar
6. close the JETPRIME throttle control housing on the electronic throttle control
7. connect the wiring to the original connectors
8. reinstall the bar end weight

FUNCTIONS

1. ON/OFF
2. HEATED GRIPS
3. MODE
4. START

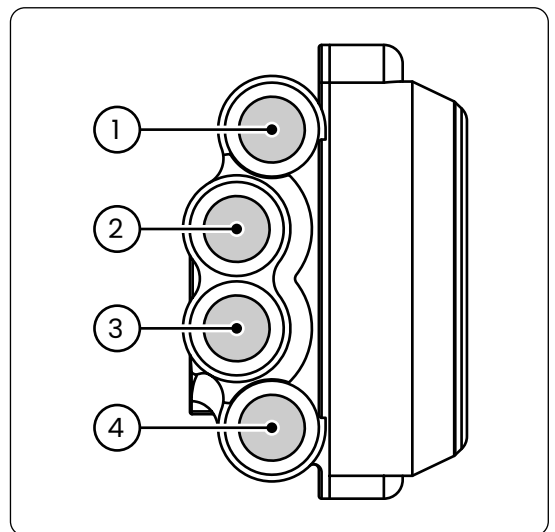



JETPRIME S.R.L.

Via Eugenio Montale, 1
41016 Novi di Modena - Rovereto sulla Secchia (MO)
Phone: +39 059 672223 - Email: info@jetprime.it

www.jetprimeshop.it

All JETPRIME products are designed for racing use only and should be installed by an expert.

The manufacturer, importer, or dealer shall not be liable for any damage caused by improper installation or operation of the JETPRIME product.

The warranty is limited to defects recognized by our technical department and to normal use. The warranty is void in case of accident, modification, improper or racing use.

Do not install the product on a motorcycle for which it was not designed or tested by JETPRIME.

The technical specifications of JETPRIME products and related products are subject to change without notice.